



The homesever talk

- *nemo*

whoami

- Nemo
- @captn3m0
- @razorpay ( )

agenda

0. what counts as a homeserver?
1. Why you should run one?
2. How do you get started?
3. All the gotchas!
4. CTA

homeserver

A computer which runs service(s) for personal use.

why?

motivation?

1. owning your data

motivation?

1. owning your data
2. de-googling

motivation?

1. owning your data
2. de-googling
3. backing up your data locally

motivation?

1. owning your data
2. de-googling
3. backing up your data locally
4. learning/experimenting with tech

motivation?

1. owning your data
2. de-googling
3. backing up your data locally
4. learning/experimenting with tech
5. playing mario

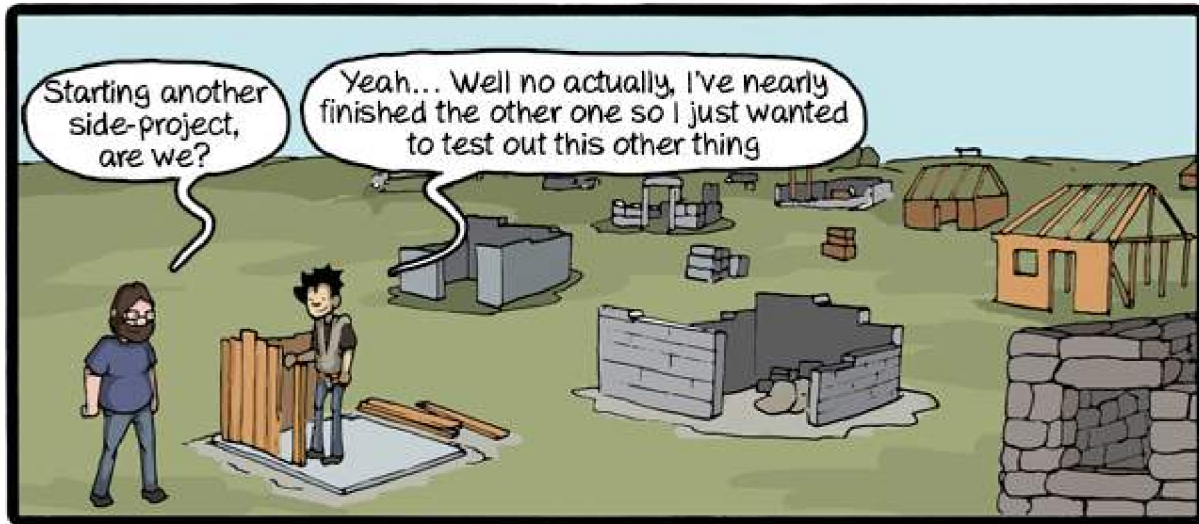
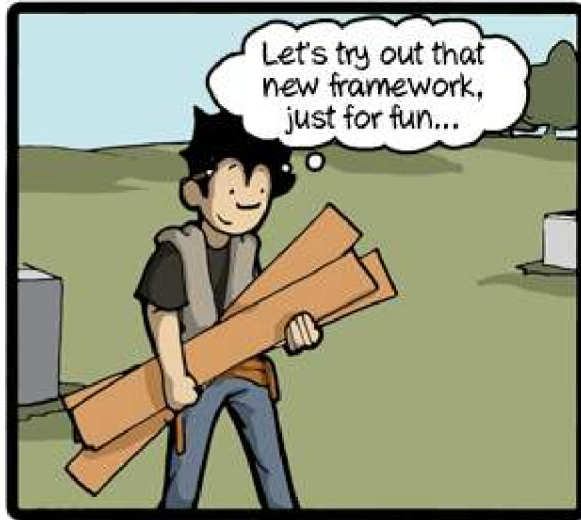

CommitStrip.com

time?

<5 hr a month

software

hardware

glue





what I run

Monitoring

- Prometheus
- Grafana
- speedtest-exporter
- ACT Exporter
- CAdvisor



Nemo

@capt3m0



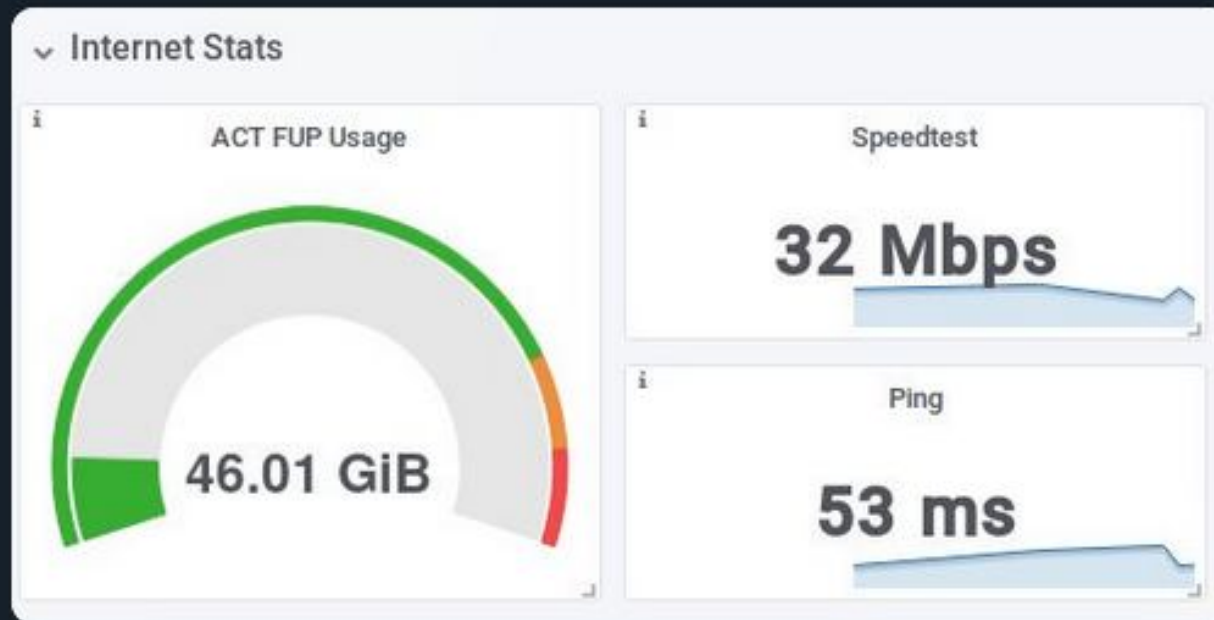

I wrote a [#prometheus](#) exporter for [@ACTFibernet](#). Opens the ACT portal with [@googlechrome](#) puppeteer and reports back the current usage. Try it out at grafana.bb8.fun

Source: [git.captnemo.in/nemo/prometheu ...](https://git.captnemo.in/nemo/prometheu...)











8:47 PM - 4 Jun 2018

Media

- Airsonic () (Google Play)
- Jellyfin () (Netflix)
- Kodi () (Home Theater)
- Audioserve ( ) (Audible)

Content

- Nextcloud   (Google Drive/iCloud)
- Miniflux ( ) (Google Reader)
- Timemachine ( )
- wiki.js
- Radicale   (Google Contacts/Google Calendar)
- RSS Bridge
- Resilio  (Dropbox)
- Gitea (GitHub)

hardware

Specs

- Intel i5-7600 3.5GHz
- Nvidia 1050 Ti 4GB
- 2x8GB DDR4 RAM
- 3x3TB Internal HDD
- MSI B250I Motherboard



- DO 1vCPU / 2GB RAM / 30GB SSD (\$10/mo) (BLR1 region)
- + 100GB disk

A VM on the

- Scaleway: 4ARMv8/2GB/50GB - **300 INR**
- AWS Lightsail: 1vCPU/512MB/20GB - **250 INR**
- Digital Ocean: 1vCPU/1GB/25GB - **350 INR**

Beware of Persistent Storage cost



- Security: Footgun
- Batteries included
- OpEx

cloud storage

Storage	Cost/month	Retail
1TB-SSD	\$100	\$99
3TB-SSD	\$300	\$224
1TB	\$25	\$45
3TB	\$75	\$84

Raspberry Pi 3

- 📝 1GB RAM
- 🌐 Wireless/BLE/Ethernet
- 🔌 4 USB ports
- 🎵 Audio/HDMI/Composite VGA
- ⚡ 2.5A
- 🛠️ ~3k INR
- 📷, GPIO



A black system76 laptop is the central focus, lying on its side on a grey surface. The laptop's lid is open, showing the 'system76' logo. The back of the laptop features a USB port, an SD card slot, and a power button. Surrounding the laptop are numerous colorful LEGO bricks and minifigures. To the left, there's a small structure made of yellow and grey bricks. In the center-left, a green minifigure stands near the laptop. To the right, a tall tower of orange and red bricks has a blue minifigure with a red cape on top. Other minifigures are scattered around, some interacting with the bricks. The scene is set on a plain, light-colored floor.

system76 Meerkat

Other Alternatives

1. Intel NUCs
2. [Hetzner Server Auctions](#) (20-50USD/mo).
3. NAS/Network device.
4. Gamer? [r/pcmasterrace/wiki](#)



have some old laptops?



really into networking?







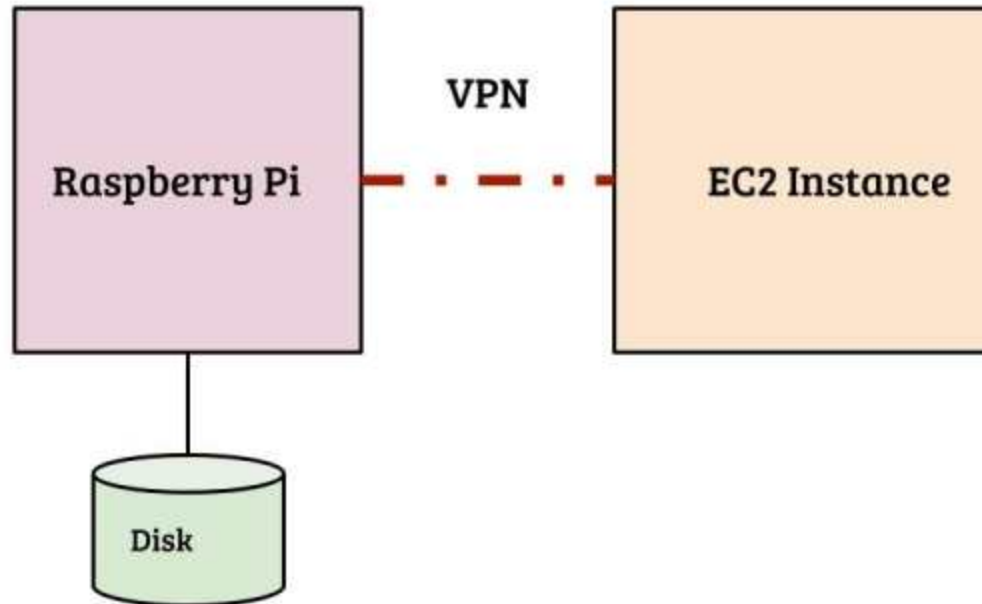

really want a cluster?

Hybrid

- Local Disk, Cloud Compute



	Cloud	Pi	PC*	Hybrid	NAS
Security 	+	++	++	+	++
Utility	+++	-		++	-
Cost		++++	++	+	++
Setup-Ease	+	+	-	--	++
Ops-Ease	++	-	+	-	++
Storage	--	-	+	++	++
Gaming	--	-	++	++	--
HTPC		+	++	++	+

glue

software

1. docker
2. kubernetes
3. ansible/puppet/chef
4. [tool-of-your-choice](#)

software

1. docker *
2. kubernetes
3. ansible/puppet/chef
4. helm?

containers?

- secure
- declarative configuration
- orchestration is 100x easier

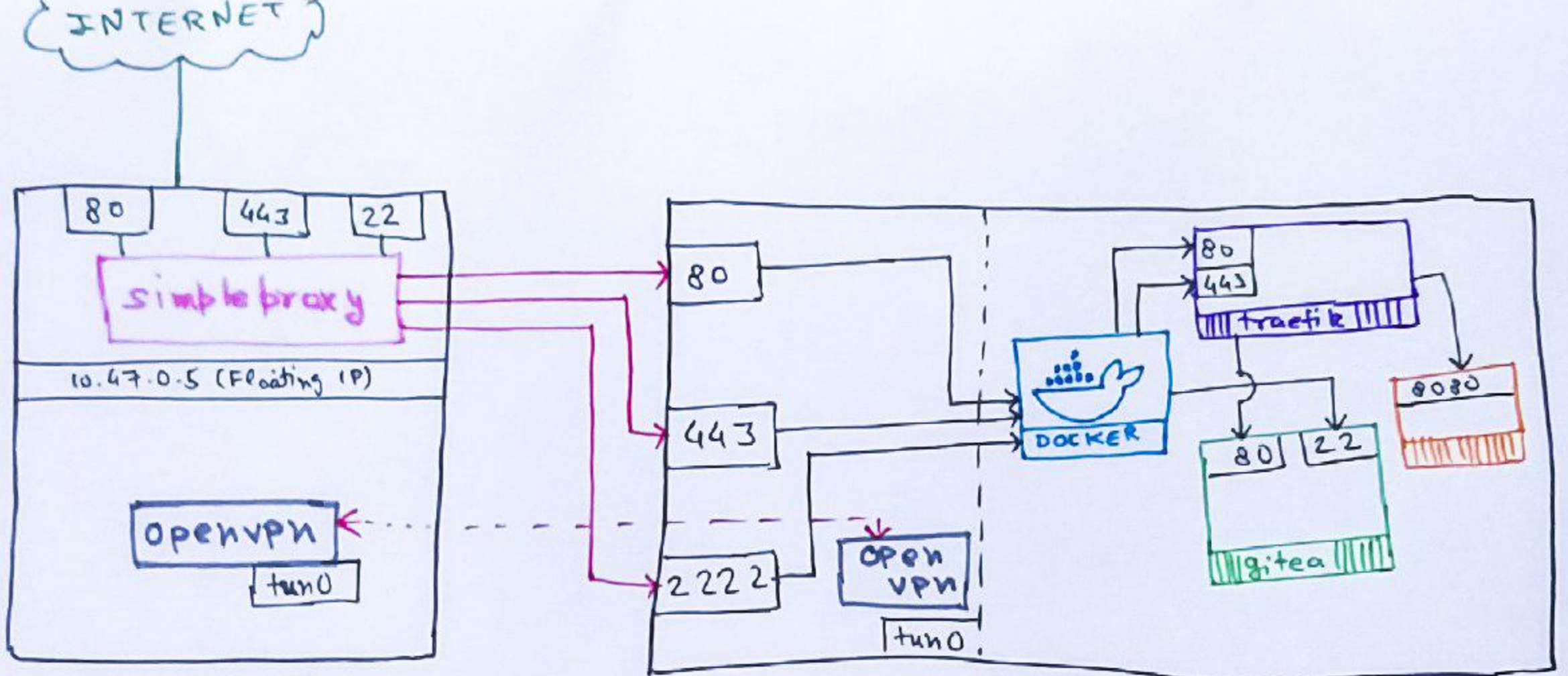

networking

- Public+Static IP Address
- Floating/Elastic IP



sydney.bb8.fun
(BLRI, Digital Ocean)

home server
(tattooine)

-  openVPN encrypted traffic
-  public internet traffic
-  internal traffic

configuration

- terraform + docker
- kubernetes + helm
- ansible + galaxy
- docker-compose

terraform

```
module "requestbin" {  
  name      = "requestbin"  
  source    = "./modules/container"  
  image     = "jankysolutions/requestbin:latest"  
  web {  
    expose = true  
    port   = "8000"  
    host   = "requestbin.bb8.fun"  
  }  
  networks = "${list(module.docker.traefik-network-id)}"  
}
```

- source: <https://git.captnemo.in/nemo/nebula>
- terraform.io/docker

Docker API

1. Manage networks,
2. Containers,
3. Configuration

All over a API, but only for one host.

docker swarm, but single host

security

1. Don't expose services
2. Expose services without auth over VPN only
3. Don't expose management services over Internet
4. Keep services behind Auth (even Basic Auth works)
5. Go Hybrid

self-hosting references

- [kickball/awesome-selfhosted](#)
- [linuxserver.io](#)
- [r/selfhosted](#)

questions?

- me@captnemo.in
- [@captn3m0](#)

questions?

- me@captnemo.in
- [@captn3m0](#)

Buy A Raspberry Pi Today!